



Turner, the new seating system designed by the designer Hannes Wettstein, combines comfort with refinement. Balanced volumes, controlled proportions, and a modern yet timeless look, characterise the design. Settees in various sizes, corner pieces, chaises-longue and pouf can be combined together to create different furnishing solutions. Molteni pays particular attention to the choice of leathers used to cover its products. They must have superior properties of softness and resistance to wear.

Turner responds to varying needs in terms of comfort and posture, thanks to an easy mechanism which adjusts the depth of the seating. *Turner* is an excellent solution to the problem of how to combine elements thanks to a design logic based on modularity for traditional sofas, compositions with chaises longues and daybed islands.



Hannes Wettstein Severe and perfect, Switzerland is a wonderful place to escape from. Hannes Wettstein knows this well, living there and travelling elsewhere with his designs. Born in 1958, Wettstein is one of the most interesting designers of his generation, a fact witnessed by the many prizes and competitions he has won, including the 2004 Compasso d'Oro for the Nomis kitchen designed for Dada. His success is in large part due to his curiosity regarding materials and all forms of creativity. From products to communication, from industrial design to architecture. Furniture, watches, lights. Long live the product seems to be his motto. He has worked for the Grand Hyatt hotel chain in Berlin, he designed the Swiss Embassies in Teheran and Washington DC, he has worked in partnership with international design companies: Cassina, UMS Pastoe, Shimano, Baleri Italia, Artemide and the Molteni Group. He started out working freelance, and then became a partner of the Eclat Design Agency. In 1993 he co-founded 9D Design. But it is with his own studio, an interdisciplinary laboratory Zed, that Wettstein really develops his all-round ability as a designer and architect, taking care of company images and creating architectural designs. For Molteni&C. Hannes Wettstein has designed various products, including the chair *Alfa*, made from avant-garde material, a resin-polyester composite reinforced with fibreglass, the chair *Dart*, ergonomic and inviting, the *Joseph* tables, useful and minimal, and beds which have become classics like *Dodicesimanotte Q* and the *Wave* series.

■ Finishes

Cover (fully removable)

fabric
leather

Feet

shiny aluminium
lacquered nickel

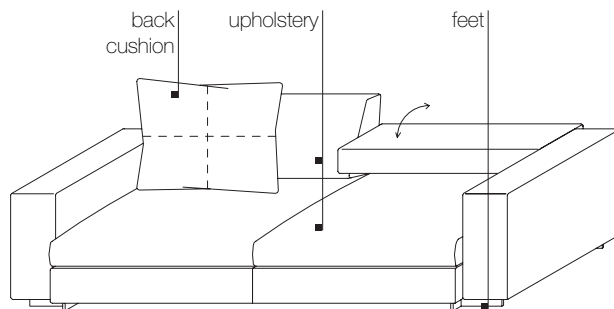

■ Dimensions

End units, central units, chaise longues and islands

Elements **cannot be used individually.**

All elements have back with mechanism.

The compositions are always closed at the side with an arm.

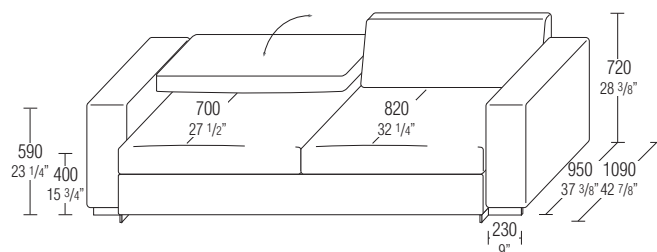

Corner

The corner element **cannot be used alone** but must be placed by a central, terminal or corner element, on the opposite side to the arm
The corner element comes with mechanism only on the long side.

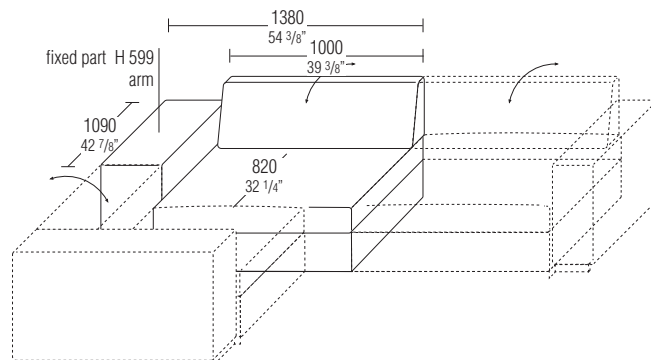
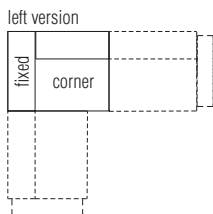

Island element

The island element cannot be used alone, but must be used along with a central, end or corner element on the side opposite the armrest.

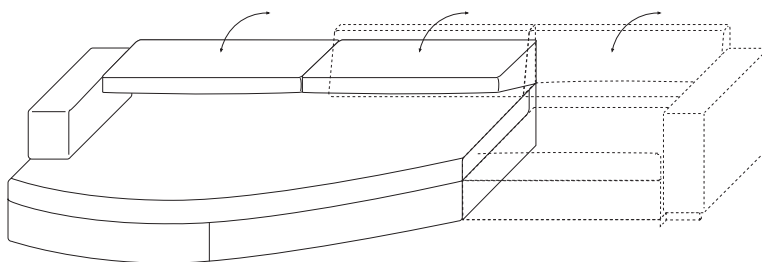
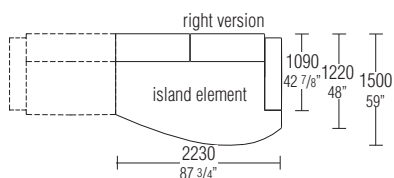

Sofa

The settee is a finite element which stands alone

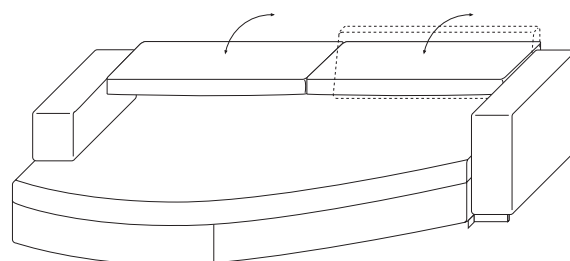
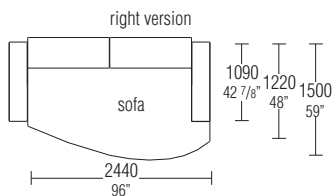

■ Elements left version

end element

W 1080 D 1090 H 590/720
W 42 1/2" D 42 7/8" H 23 1/4" - 28 3/8"

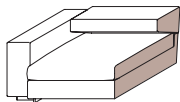

T108 dx - sx

W 1230 D 1090 H 590/720
W 48 3/8" D 42 7/8" H 23 1/4" - 28 3/8"

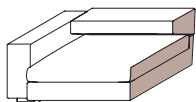

T123 dx - sx

W 1430 D 1090 H 590/720
W 56 1/4" D 42 7/8" H 23 1/4" - 28 3/8"

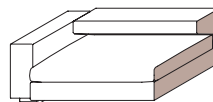

T143 dx - sx

central

W 850 D 1090 H 590/720
W 33 1/2" D 42 7/8" H 23 1/4" - 28 3/8"

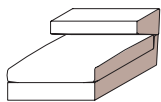

CE85

W 1000 D 1090 H 590/720
W 39 3/8" D 42 7/8" H 23 1/4" - 28 3/8"

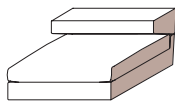

CE100

W 1200 D 1090 H 590/720
W 47 1/4" D 42 7/8" H 23 1/4" - 28 3/8"

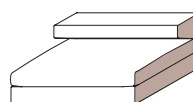

CE120

chaise longue

W 1080 D 2100 H 590/720
W 42 1/2" D 82 3/4" H 23 1/4" - 28 3/8"

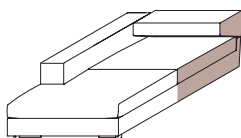

CL108 dx - sx

W 1230 D 1600 H 590/720
W 48 3/8" D 63" H 23 1/4" - 28 3/8"

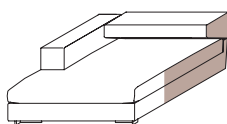

CL123 dx - sx

island

W 1080 D 2100 H 590/720
W 42 1/2" D 82 3/4" H 23 1/4" - 28 3/8"

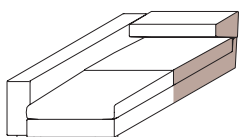

IS108 dx - sx

W 1230 D 1600 H 590/720
W 48 3/8" D 63" H 23 1/4" - 28 3/8"

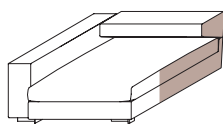

IS123 dx - sx

W 1430 D 1600 H 590/720
W 56 1/4" D 63" H 23 1/4" - 28 3/8"

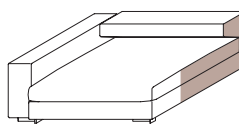

IS143 dx - sx

W 2230 D 1500 H 590/720
W 87 3/4" D 59" H 23 1/4" - 28 3/8"

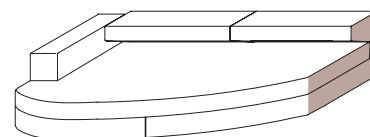

IS223 dx - sx

corner

W 1380 D 1090 H 590/720
W 54 3/8" D 42 7/8" H 23 1/4" - 28 3/8"

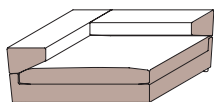

AN138 dx - sx

sofa

W 2440 D 1500 H 590/720
W 96" D 59" H 23 1/4" - 28 3/8"

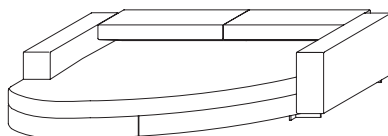

DI244 dx - sx

pouf

W 1000 D 850 H 400
W 39 3/8" D 33 1/2" H 15 3/4"

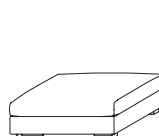

PF100

pouf

W 1200 D 1000 H 400
W 47 1/4" D 39 3/8" H 15 3/4"

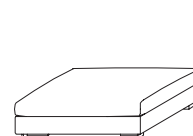

PF120

back cushion

W 600 H 600
W 23 5/8" D 23 5/8"

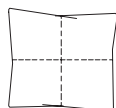

TCS60

W 700 H 600
W 27 1/2" D 23 5/8"

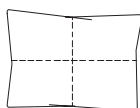

TCS70

W 800 H 600
W 31 1/2" D 23 5/8"

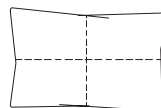

TCS80

pair of extra cushions

W 500 H 500
W 19 3/4" D 19 3/4"



CCQ/50